

Qualiton P200 © User's Manual

CONTENTS

IMPORTANT SAFETY INSTRUCTIONS	4	AC MAINS CONNECTION	34
MARKINGS	8	DESCRIPTION OF THE P200's BIAS SYSTEM	35
PREFACE	9	REPLACEMENT OF FUSE	36
BASIC INFORMATIONS	10	WASTE MANAGEMENT	37
TECHNICAL ASSISTANCE AND SERVICE INFORMATION ...	11		
STEREO MODE SPECIFICATIONS	12		
BRIDGE MODE SPECIFICATIONS	13		
GENERAL SPECIFICATIONS	14		
FRONT PANEL	15		
REAR PANEL	16		
UNPACKING	18		
CONTENTS OF PACKAGE	21		
PLACEMENT	22		
INSTALLATION OF VACUUM TUBES	23		
USING THIRD PARTY VACUUM TUBES	26		
OPERATING MODES OF THE P200	27		
STEREO MODE OPERATION	28		
BRIDGE MODE OPERATION	29		
AMPLIFIER BLOCK DIAGRAM	30		
CONNECTION DIAGRAM - STEREO MODE	31		
CONNECTION DIAGRAM - BRIDGE MODE	32		
LOUDSPEAKER CONNECTIONS	33		

IMPORTANT SAFETY INSTRUCTIONS

PLEASE READ THEM BEFORE OPERATING THIS EQUIPMENT.



1. Read these instructions.
2. Keep these instructions.
3. Heed all warnings.
4. Follow all instructions.
5. Improper installation may cause malfunction.
6. Do not use this apparatus near water.
7. Clean only with a dry cloth.
8. Do not block any ventilation openings since this may lead to fire. Install in accordance with the manufacturer's instructions.
9. Do not install near any heat sources such as radiators, heat registers, stoves, or other apparatus (including amplifiers) that produce heat.
10. Do not defeat the safety purpose of the polarized or grounding-type plug. A polarized plug has two blades with one wider than the other. A grounding type plug has two blades and a third grounding prong. The wide blade or the third prong are provided for your safety. If the provided plug does not fit into your outlet, consult an electrician for replacment of the obsolete outlet.
11. Connect mains power supply cord only to a mains socket outlet with a protective earthing connection.
12. Be careful with appliance cables. Do not lead

IMPORTANT SAFETY INSTRUCTIONS

PLEASE READ THEM BEFORE OPERATING THIS EQUIPMENT.



them across sharp surfaces, do not clam them together and do not leave them in a hanging position. Protect the power cord from being walked on or pinched particularly at plugs, convenience receptacles, and the point where they exit from the apparatus.

13. You must not operate the appliance with damaged cables.

14. Before powering up your amplifier, make sure protective cover, ports, plugs and cables are checked for intactness.

15. Only use attachments/accessories specified by the manufacturer.

16. Use only with the cart, stand, tripod, bracket, or table specified by the manufacturer, or sold with the

apparatus. When a cart is used, use caution when moving the cart/apparatus combination to avoid injury from tip-over.



17. Unplug this apparatus during lightning storms or when unused for long periods of time.

18. **No user-serviceable parts inside.** Improper repair may lead to loss of warranty. Refer servicing to qualified service personnel.

19. Servicing is required when the apparatus has been damaged in any way, such as power supply cord or plug is damaged, liquid has been spilled or objects have fallen into the apparatus,

IMPORTANT SAFETY INSTRUCTIONS

PLEASE READ THEM BEFORE OPERATING THIS EQUIPMENT.



the apparatus has been exposed to rain or moisture, does not operate normally, or has been dropped.

20. You must not start up damaged or faulty appliance. In case of any malfunction, unplug your amplifier immediately.

21. In case of a malfunction, the protective cover must not be opened or removed.

22. Do not expose this equipment to dripping or splashing and ensure that no objects filled with liquids, such as vases, are placed on the equipment.

23. Do not touch the appliance or its mains cable with wet hands.

24. In case of fire, you must not use water to

extinguish the fire, even if the amplifier is switched off.

25. The appliance may only be used by qualified adults or children above 14 years of age if supervised by a qualified adult.

26. Keep the appliance out of the reach of children.

27. Make sure your domestic animal does not lie or sit on the top of the appliance.

28. If you do not use your amplifier for a long time, unplug the appliance carefully.

29. To completely disconnect this equipment from the AC mains, disconnect the power supply cord plug from the AC receptacle.

IMPORTANT SAFETY INSTRUCTIONS

PLEASE READ THEM BEFORE OPERATING THIS EQUIPMENT.



30. The mains plug of the power supply cord shall remain readily operable.

31. Do not expose batteries to excessive heat such as sunshine, fire or the like.

32. **WARNING!** To reduce risk of fire or electrical shock, do not expose this equipment to rain or moisture.

33. **CAUTION!** To reduce the risk of electric shock, do not remove cover.

MARKINGS

 The exclamation point within an equilateral triangle is intended to alert the user to the presence of important operating and maintenance (servicing) instructions in the literature accompanying the appliance.

 CAUTION! Hot Surface! Do Not Touch!
Protective cover of the product may become hot when operating this product continuously.

 The crossed-out wheeled bin is the European Union symbol for indicating separate collection for electrical and electronic equipment. This product contains electrical and electronic equipment which should be reused, recycled or recovered and should not be disposed of with unsorted regular waste. Please return the unit or contact the authorised dealer from whom you purchased this product for more information.

 The product meets the relevant directives and standards of the European Union.

 Supplied with alternating current (AC).

115 V / 230 V Nominal supply voltage.

50 Hz / 60 Hz Nominal supply frequency.

PREFACE

Before installing the Qualiton P200 stereo vacuum tube power amplifier, please study this user manual carefully.

Operating your power amplifier in a manner it is designed for, ensures you an utmost musical experience and a reliable operation.

If you have any questions on our products or services, please do not hesitate to contact us on our website: www.audiohungary.com

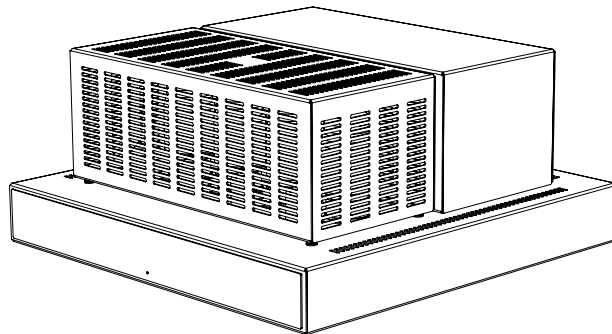

BASIC INFORMATION

For your convenience, please fill out the following lines to facilitate any future technical assistance and repair service:

Serial Number:

Date of purchase:

Dealer Name:

TECHNICAL ASSISTANCE AND SERVICE INFORMATION

If at any time you have any questions about your Qualiton product, do not hesitate to contact your local Qualiton dealer, who is at your disposal. If you or your dealer need more help, you can receive technical assistance at:

Audio-Hungary Ltd.
132 Derkovits Street
4400, Nyíregyháza, Hungary
Phone: +36 42 446-688
Fax: +36 42 446-688

If it becomes clear that your Qualiton product needs service, you should still contact your local dealer first. You can also contact us directly for more instructions at one of the contact details above.

STEREO MODE SPECIFICATIONS

Rated output power	2 x 100 W
Input impedance, Balanced Stereo IN	40 kOhm
Input impedance, Unbalanced Stereo IN	10 kOhm
Input sensitivity, Balanced Stereo IN	480 mV, to rated output
Input sensitivity, Unbalanced Stereo IN	480 mV, to rated output
Gain	+35.4 dB (RL = 8 Ohm)
Frequency response	18 Hz to 60 kHz (-3 dB, rated output)
Total Harmonic Distortion	< 1.2% (f = 1 kHz, rated output)
Signal-to-noise ratio	> 100 dB (RL = 8 Ohm, rated output)
Load impedance	4 or 8 Ohm

BRIDGE MODE SPECIFICATIONS

Rated output power	1 x 200 W
Input impedance, Bridge IN	20 kOhm
Input sensitivity, Bridge IN	1V, to rated output
Gain	+32 dB (RL = 8 Ohm)
Frequency response	20 Hz to 55 kHz (-3 dB, rated output)
Total Harmonic Distortion	< 2% (f = 1 kHz, rated output)
Signal-to-noise ratio	> 100 dB (RL = 8 Ohm, rated output)
Load impedance	8 Ohm

GENERAL SPECIFICATIONS

Number of input ports / channel	1 unbalanced Stereo IN
	1 balanced Stereo IN
	1 balanced Bridge IN
Number of output ports / channel	1 unbalanced Power OUT
Tubes required	4 x KT120 (KT150 or KT170 optionally)
	2 x 6922
	2 x 12AX7
Weight	26 kg
Dimensions	43 x 46 x 21 cm
Power requirement	720 W

FRONT PANEL

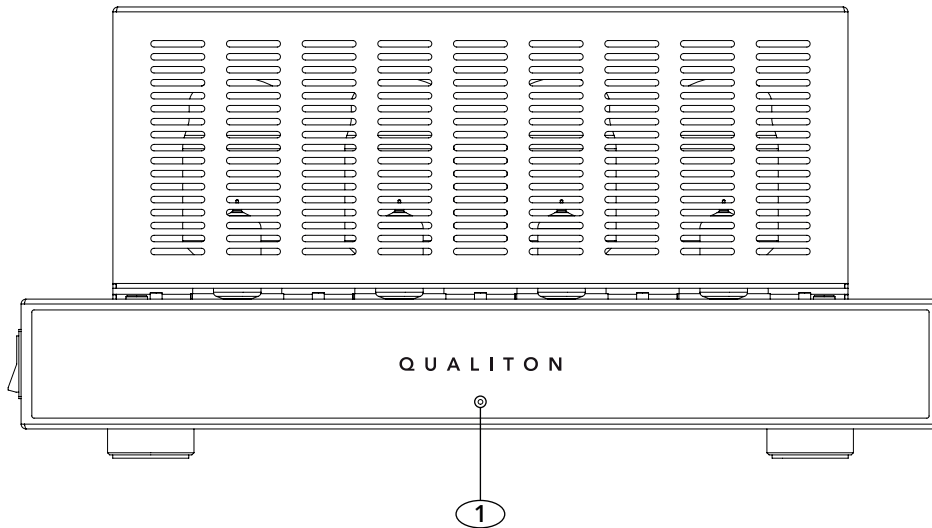

1. POWER ON indicator LED.

REAR PANEL

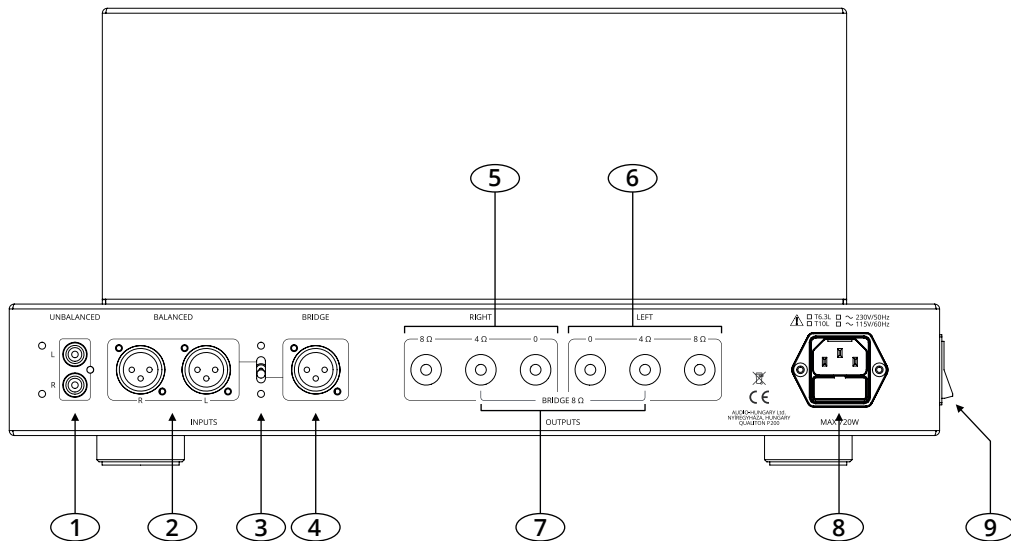

REAR PANEL

1. UNBALANCED STEREO INPUT accepts high level, stereo program source signal.

2. BALANCED STEREO INPUT accepts high level, stereo program source signal.

3. STEREO INPUT / BRIDGE INPUT selector switch.

4. BALANCED BRIDGE INPUT accepts high level, monaural program source signal.

5. RIGHT POWER OUTPUT - Connections for a 4 or 8 Ohm loudspeaker.

6. LEFT POWER OUTPUT - Connections for a 4 or 8 Ohm loudspeaker.

7. BRIDGE POWER OUTPUT - Connections for a 8 Ohm loudspeaker.

WARNING! In BRIDGE mode the amplifier has a differential floating output, none of the output terminals must be connected to ground potential.

8. IEC Appliance AC INLET with built-in main fuse holder to connect the Qualiton P200 to a live AC outlet.

9. MAIN SWITCH with position indicator.

UNPACKING

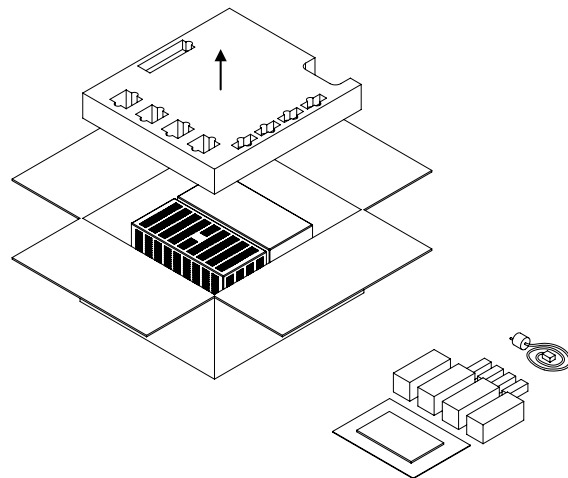
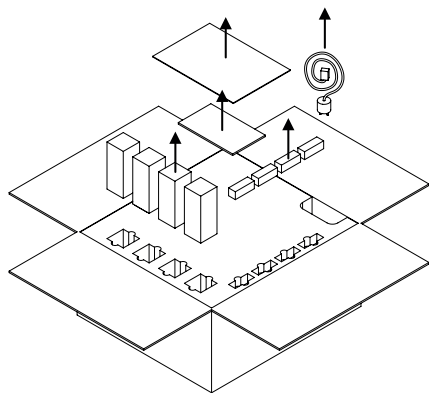

UNPACKING

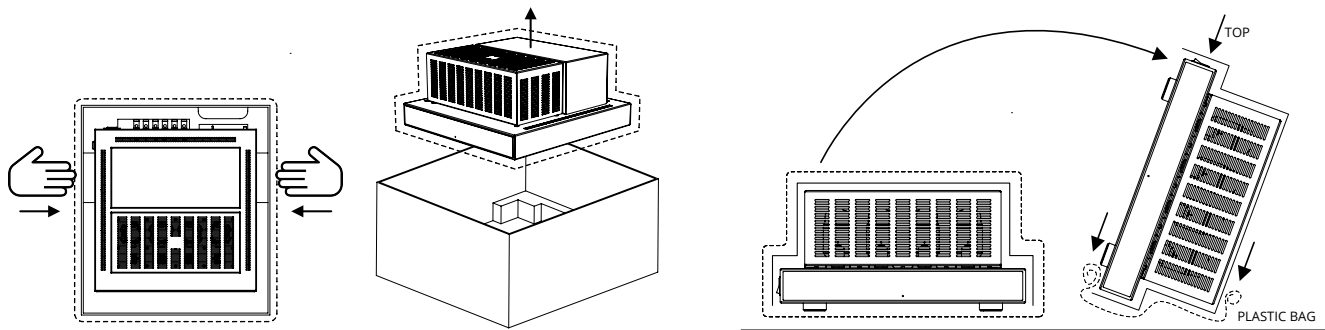

UNPACKING

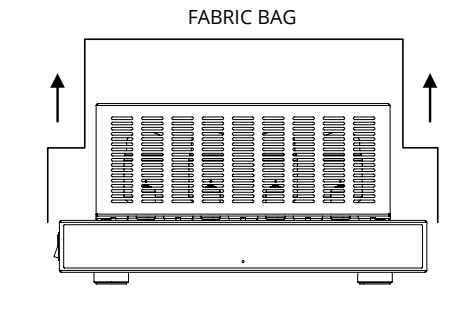
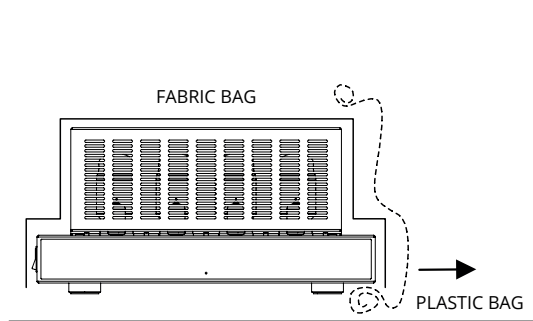

CONTENTS OF PACKAGE

Once you have unpacked the entire contents of the package, you can now check that you have received all the accessories.

- 1 pc Qualiton P200 power amplifier
- 1 pc User's Manual
- 4 pcs KT120 / KT150 power tubes
- 2 pcs 6922 vacuum tubes
- 2 pcs 12AX7 vacuum tubes
- 1 pc Standard Mains Cable

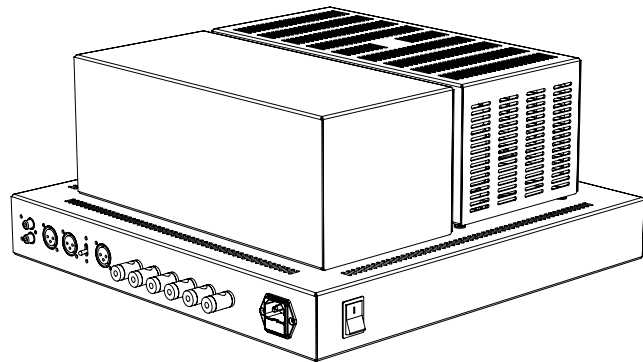

PLACEMENT

- Please read the following carefully to select a proper location for your amplifier.
- **IMPORTANT!** Due to the vacuum tube construction of the amplifier, it may heat up during use. Thus, choose a location for installation where the appliance can be well ventilated.
- The ventilation holes of the amplifier must not be covered (by tablecloth, curtain, newspaper, book, etc.). Impairing ventilation can lead to overheating and irregular operation conditions.
- Do not stack multiple units on top of each other.
- Avoid relocating the appliance from a cold to a warm environment. Sudden temperature changes can lead to moisture condensation. Please wait until moisture is evaporated before putting your amplifier into operation.
- The aforesaid applies to the very first installation of the appliance as well. Prior to the first installation, leave the amplifier at its place of operation at least for 2 hours. Once this time is over, the amplifier can be powered up, according to this guide.
- The appliance is designed for indoor use. Do not operate it in wet, humid environment.

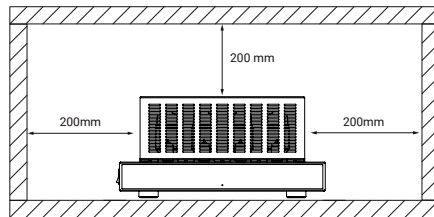

- Do not store any electrical device or object in a perimeter of 200 millimetres around your amplifier. Do not use the appliance next to heating sources and radiators. Keep it away from hot or dusty environment and flame.

INSTALLATION OF VACUUM TUBES

- You have to remove the protective cover to prepare for the insertion of the electron tubes. Because the protective cover locks in place with relatively high resistance, be careful not to scratch the device while removing it. See the figure below.
- Remove the first vacuum tube from the box labeled KT120 (V1) and carefully place it in its position (labeled V1: KT120 / KT150 on the amplifier). Make sure that the position of the small 'key' on the bottom of the vacuum tube matches the position of the notch in the middle of tube socket and fits in it correctly (as shown in the figure).
- Repeat the same steps with the three remaining KT120 tubes (V2, V3, and V4). If all four power tubes are in place, the driver tubes may follow.
- Remove a tube from one of the boxes labeled 12AX7 and carefully place it in one of the positions labeled 12AX7 / ECC83 on the amplifier. Make sure that the holes in the electron tube socket fit the pins of the electron tube correctly. See the figure below.
- Repeat the previous step with the other 12AX7 tube.
- Remove a tube from one of the boxes labeled 6922 and carefully place it in one of the positions labeled 6922 / E88CC on the amplifier. Make sure that the holes in the electron tube socket fit the pins of the electron tube correctly. See the figure below.
- Repeat the previous step with the other 6922 tube.
- Carefully put the protective cover back in place. See the figure below.

INSTALLATION OF VACUUM TUBES

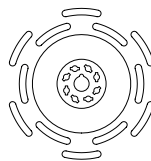
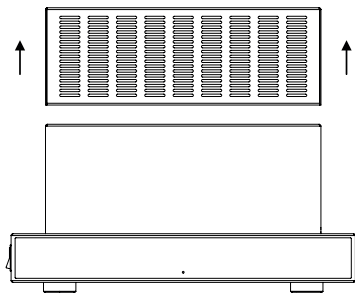

V1: KT120 / KT150



6922 / E88CC

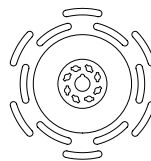

V2: KT120 / KT150



12AX7 / ECC83

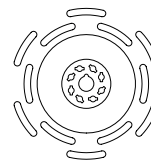

V3: KT120 / KT150



12AX7 / ECC83

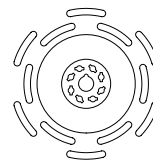

V4: KT120 / KT150



6922 / E88CC

INSTALLATION OF VACUUM TUBES

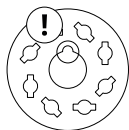
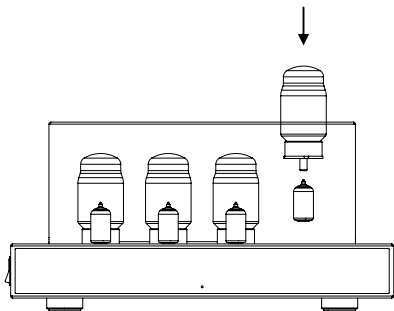

KT120 / KT150

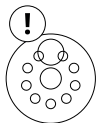

6922 / E88CC

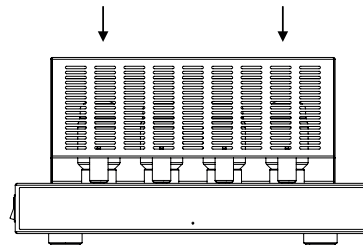

USING THIRD PARTY VACUUM TUBES

- Audio-Hungary Ltd. does not recommend the use of any other electron tubes in the P200 power amplifier other than those supplied with the device.
- Audio-Hungary Ltd. cannot and does not warrant against, and shall have no liability of any kind for any defects resulting from the use of vacuum tubes from third parties and such defects will void the warranty.

OPERATING MODES OF THE P200

- The P200 has two distinct modes of operation, STEREO and BRIDGE mode. You can change the operating mode by reconfiguring the output connections as shown in the CONNECTION DIAGRAMS. You can then use the STEREO INPUT / BRIDGE INPUT selector switch to select the input source for the chosen operation mode.
- In order to properly configure the P200 within your sound system according to your needs, please now carefully study this section and the AMPLIFIER BLOCK DIAGRAM / CONNECTION DIAGRAMS.

STEREO MODE OPERATION

- In STEREO mode the P200 can be used as a conventional stereo power amplifier to which you can connect an UNBALANCED or BALANCED stereo input signal. These two STEREO inputs cannot be used at the same time. In case a signal source is connected to both of them, a built-in control logic feeds the P200 from the BALANCED input, and the UNBALANCED input is ignored.
- In STEREO mode the amplifier has two unbalanced outputs for 4 or 8 Ohm speakers, with a maximum available output power of 2 x 100 W.

BRIDGE MODE OPERATION

- In BRIDGE mode the P200 can be used as a monoblock power amplifier with a BALANCED input. In this mode, the two channels of the stereo amplifier are fed from a monaural, symmetrical audio signal (BRIDGE input), and a single 8 Ohm loudspeaker can be connected between the two amplifier outputs, bridging the output terminals. The maximum available bridged, monaural output power is 1 x 200 W.
- In BRIDGE mode, you can concentrate the total output power of the P200 into a single, monaural channel. It means that two BRIDGE mode P200s are required to build a STEREO sound system with output power of 2 x 200 W.

AMPLIFIER BLOCK DIAGRAM

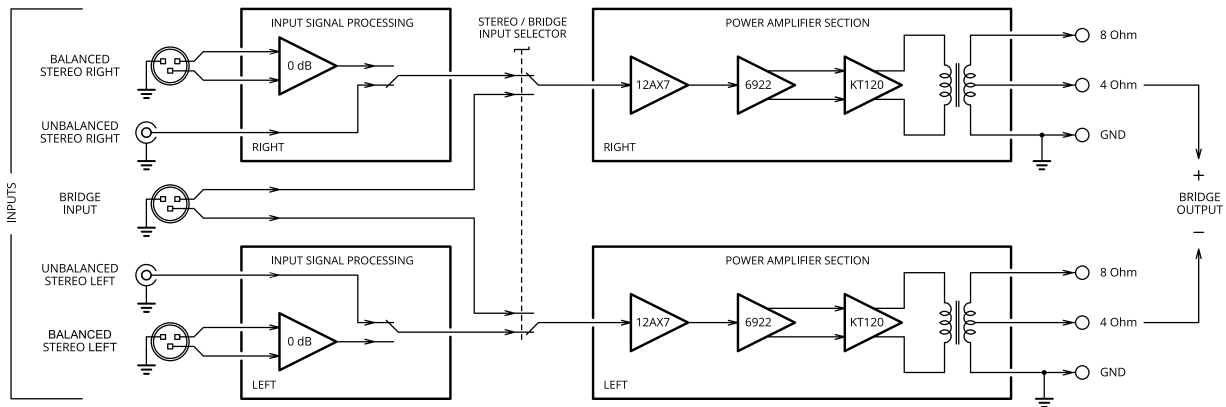

CONNECTION DIAGRAM - STEREO MODE

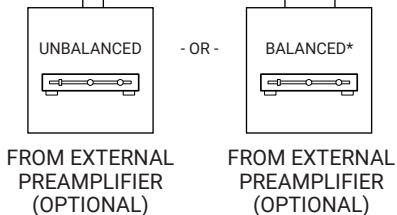
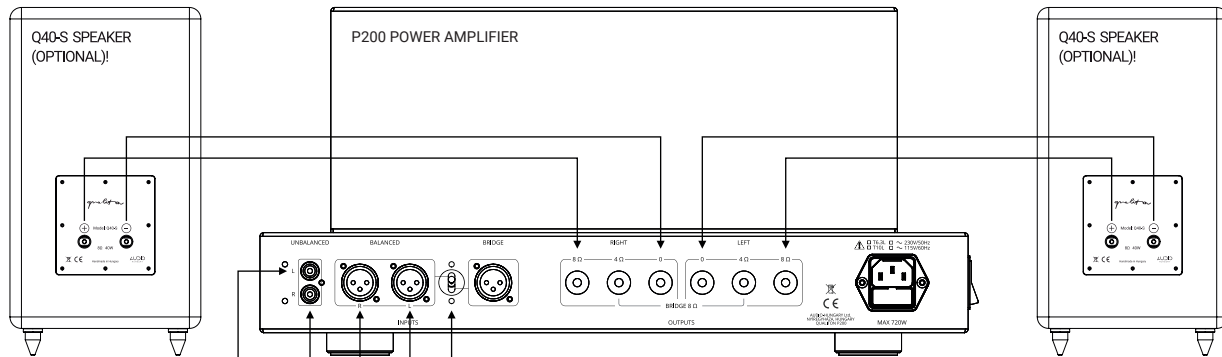

* If a signal source is connected to the BALANCED stereo input, the UNBALANCED stereo input is ignored.

CONNECTION DIAGRAM - BRIDGE MODE

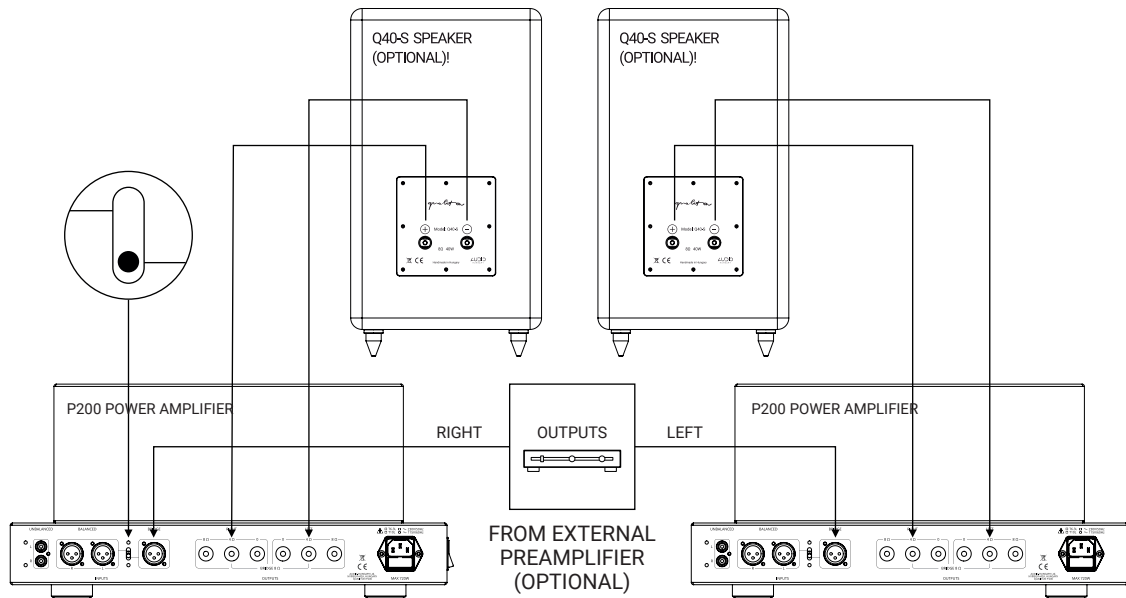

LOUDSPEAKER CONNECTIONS

- Depending on the operating mode you wish to use (STEREO or BRIDGE), connect your speakers to the P200's outputs according to the corresponding CONNECTION DIAGRAM.
- Do not turn on the amplifier until proper loads are connected to their respective output terminals (4 or 8 Ω , marked on the amplifier).
- **WARNING!** In BRIDGE mode the amplifier has a differential floating output, none of the output terminals must be connected to ground potential.

AC MAINS CONNECTION

- The Qualiton P200 is factory configured for one of the following AC Mains Voltages:
 - ~ 115 V/60 Hz at 10.0 Amps
 - ~ 230 V/50 Hz at 6.3 Amps
- **WARNING! Do not connect any external source to the appliance until you have connected it to a mains socket outlet with a protective earthing connection.**
- Make sure you want to operate the P200 at the AC mains voltage and frequency marked on the back.
- The standard IEC power inlet with fuse holder are placed on the rear panel.
- The amplifier is of Class 1 construction and must be connected to a mains socket outlet with a protective earthing connection.
- The appliance can be operated safely only with the supplied standard IEC mains cable.

DESCRIPTION OF THE P200'D BIAS SYSTEM

- The P200 features a sophisticated, microprocessor-based, fully automatic bias control system for the four power tubes. This circuit continuously monitors the behavior of each tube and regulates the bias voltages accordingly.
- The above means that no further adjustment is required once the electron tubes supplied with the unit have been installed.

REPLACEMENT OF FUSE

The IEC power inlet features a built-in fuse holder. The specification of replacement fuses are: T 6.3 L for 230 V AC mains and T 10.0 L for 115 V AC mains.

1. Open the fuse holder with a screwdriver.
2. Change the used main fuse (b.) for the spare fuse (a.).

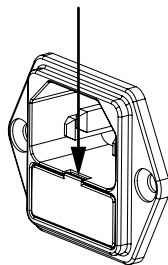

1.

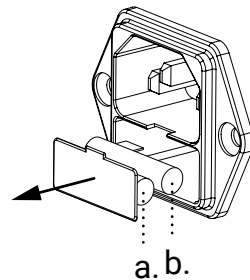

2.

WASTE MANAGEMENT

- The appliance and its packaging are made of recyclable materials.
- The appliance contains repairable or recyclable components and materials. Waste separation makes their recycling possible.
- A faulty appliance or an appliance meant to be discarded has to be sent or brought to an adequate waste collection place or to our company site.
- For further information on waste disposal please contact our company or local authorities.



Audio-Hungary Ltd. Hungary
132 Derkovits Street 4400 Nyíregyháza

WWW.AUDIOHUNGARY.COM